

# A Fluid-Suspension, Electromagnetically Driven Eye with Video Capability for Animatronic Applications

Katie Bassett, Marcus Hammond, and Lanny Smoot, *Member, IEEE*

**Abstract**— We have prototyped a compact, fluid-suspension, electromagnetically-rotated animatronic eye. The eye features extremely low operating power, a range of motion and saccade speeds that can exceed that of the human eye, and an absence of frictional wear points. The design has no external moving parts, easing its installation in new and retrofit animatronic applications. It allows a clear view through the entire structure from front to back, making a rear, stationary video camera possible. The camera view is supported without a large entrance pupil and is stationary even during rotation of the eye. Two of these devices can support stereo viewing. In a special application, the eye can be separated into a hermetically sealable portion that might be used as a human eye prosthesis, along with an extra-cranially-mounted magnetic drive.

## I. INTRODUCTION

MUCH of human expression and communication is based subtly, and in some cases overtly, on eye contact, eye movement, and signaled gaze direction [2], [7] and [12]. If the old adage “the eyes are the windows to the soul” is true, then robotic eyes that mimic the subtle movements and appearance of the human eye are the key to approximating a soul in animatronic figures (human-sized robots that may be used for theme-park applications). This is critical to fostering a more believable and engaging interactive experience.

## II. PREVIOUS WORK

Researchers around the world have created many types of robotic eyes, numerous methods for actuating them, and in some cases, have linked them to video cameras. The applications are myriad, spanning animatronics, health-care robotics, the emerging efforts towards domestic robots [16] and even toys [21]. Examples of some previously developed eye mechanisms are the dual video-camera eyes of the COG robot [8], the affective eyes used in Kismet [6], the eyes of the iCAT [22] robot and the tendon-driven MAC-EYE [5]. These prior approaches require external motive parts such as motors, screw-drive type mechanisms, external struts, string-pulleys, belts, gears, etc. Several spherical drive systems that

cannot easily be applied to eyeball movement have also been proposed. A piezoelectric inchworm spherical drive system [25] cannot achieve the requisite rotational speeds. A number of electromagnetically rotated spherical motors [13], [10], [11] and [18], pan and tilt a central metal rotor using electromagnetic stator coils. However, the opaque rotor precludes the passing of light through to a stationary camera. Other researchers have proposed miniature, very high performance pan-tilt mechanisms [3], [4] and [23], for small video cameras (similar to an early version of our Eye) but these create additional complications and wear points (commutators, ultra-flexible wiring and frictional losses) to get power to the moving camera and to get signal from it. Additionally, because of their large surrounding coils, these electromagnetic systems would be difficult to mount into an existing animatronic head.

## III. MOTIVATION

Each of these prior approaches to spherical movement on a small scale has critical drawbacks when realistic animatronic eye installations are considered. In cases where electromechanical or pneumatic/hydraulic eye-movement systems are already installed, it would be desirable to upgrade them to increase reliability and/or add video functionality. A major issue is size; the eyeball itself is often dwarfed by the mechanical equipment used to yaw and tilt it. Previous systems involve external moving parts that require mounting fixtures and space for their movement. Traditionally, retrofitting a new eye system into pre-existing animatronics is complicated by the size issue, necessitating complete removal of the old drive equipment.

In some cases, animatronic eyes cannot perform at the speeds needed to simulate human eye movement, or they have discontinuous (stepper-like) motion capability. Additionally, many of these devices require closed-loop servo control with the attendant need for potentiometer, optical, magnetic, or other position-sensing mechanisms. Many current theme-park animatronic figures do not support video tele-operation, or computer-vision-based interactivity.

## IV. OVERVIEW

To address these challenges, we propose a new approach to robotic eye design that eases the upgrading of conventional electromechanically operated eyes. The design is compact and can be rigidly embedded in a cavity. In addition, it brings the possibility of new applications to older animatronics such as video sensing for gaze direction, interactivity, and remote tele-operation. The new eye also

Manuscript received June 15, 2009. This work was supported by Disney Research.

K. Bassett is with Disney Research, Walt Disney Imagineering, Glendale, CA 91201 USA (e-mail: katherine.m.bassett@disney.com).

M. Hammond was with Disney Research, Glendale, CA 91201 USA. He is now with the Department of Mechanical Engineering, Stanford University, Stanford, CA 94305 USA (e-mail: marcus.m.hammond@gmail.com).

L. Smoot is with Disney Research, Walt Disney Imagineering, Glendale, CA 91201 USA (phone: 818-553-6896 e-mail: lanny.s.smoot@disney.com).

provides an improved aesthetic as its outside remains stationary, yet appears to rotate and slide under the surface of any overlapping skin. Finally, due to the inherent low friction of the fluid suspension, very little power is required to operate the eye. This allows for applications in battery-operated toys and autonomous interactive systems. The final eye was derived somewhat iteratively from a series of concept models as described below.

## V. DESCRIPTION OF THE EYES

### A. A Magnetically Driven Precursor

We started with a desire to create a special effect that would allow the gaze direction of an eerie eyeball, floating in a bowl, to follow viewers as they meander by.

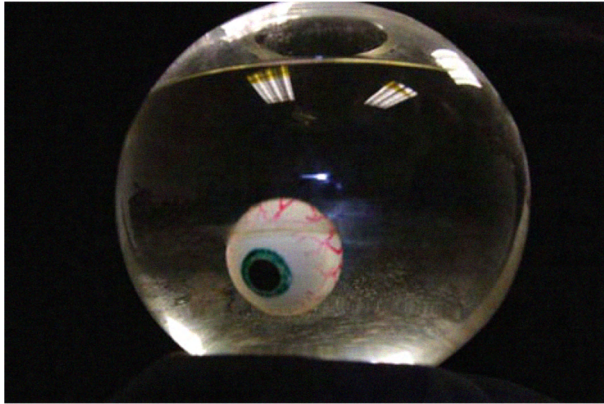


Fig. 1. A first manifestation of a floating eye suspended in liquid.

The Eye, Figure 1, was yawed and tilted through the use of a bar magnet, hidden inside the eye, that would attempt to align itself with a swiveling, permanent magnet hidden in a base under the bowl.

In order to achieve a submerged but vertically located eye, it was suspended at the interface between two liquids with differing specific gravities. The liquids were also selected to have approximately the same index of refraction so that the interface between them was nearly invisible. We used strong, rare-earth magnets, and due to the nearly friction-free suspension, the effect operates beyond the distances most would suspect possible of magnetic drive.

An external camera and image tracker were used to detect the position of passersby, and custom software was developed to drive a compact servo assembly that moved the magnet in the base. The assembly oriented the hidden magnet in a wide range of yaw and tilt angles. The eye mimicked this orientation and stared at viewers as they moved around the eye.

### B. Self-Contained Electromagnetically-Driven Eye

Interest in possible uses of an electromagnetically-driven eye in animatronic figures caused the authors to move on to prototype a compact eye that could be a direct replacement for existing electromechanical and/or pneumatic/hydraulic systems.

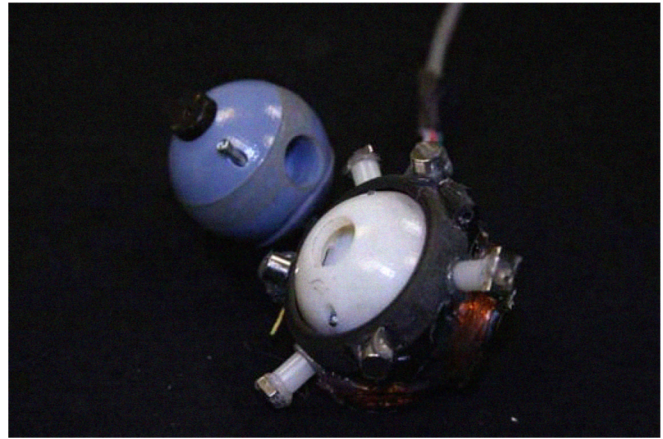


Fig. 2. Self-Contained Eyes (Side View). The first manifestation of an electromagnetically driven eye.

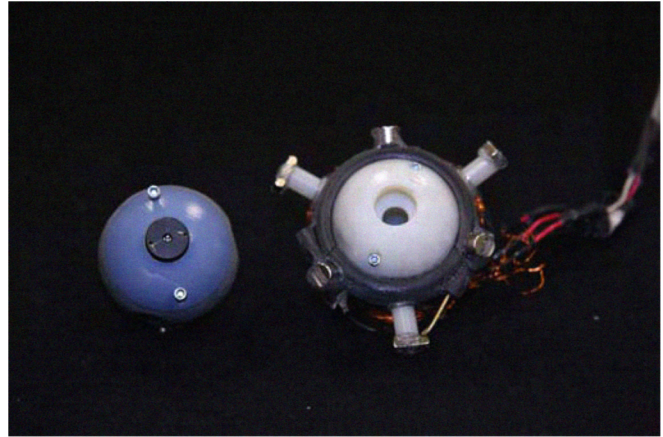


Fig. 3. Self-Contained Eyes (Front View).

The first attempt, shown in Figure 2 and Figure 3, and in the accompanying video, used an opaque plastic eyeball (white in figure) with three embedded permanent magnets located at 120 degree intervals along a great circle perpendicular to the eye's pupil gaze direction. A three-coil electromagnetic drive structure was mounted on a stereo-lithographically fabricated plastic eye socket. Each electromagnet could pull or push on its analogous permanent magnet, to tilt or yaw the eyeball. A dusting of graphite powder was used to lubricate the close-fitting socket, and to allow the eye to rotate freely. In order to prevent the eye from pitching around its viewing axis (which, while possible in humans [19], does not happen under most circumstances), three small permanent magnets (located on the socket, closest to the eyeball) biased the eye against rotation. It was also desired that the control mechanism be as simple as possible, so three additional magnets (on spacers) provide a predictable return-to-center torque. This eliminates the need for servo position sensing, or the use of power when the eyes are in their nominal, straight-ahead, position. We show a version of this eyeball with a built-in camera to the left of the basic eye in Figure 2 and Figure 3 (with magnets removed). It used an internal battery and wireless transmitter to send its video to an off-board video monitor.

## VI. FLUID-SUSPENSION ELECTROMAGNETICALLY DRIVEN EYE

The final Eye, shown in Figure 4 and Figure 5, and in the accompanying video, uses a combination of the liquid suspension of the first concept, and the compact electromagnetic drive of the second.

At this point the authors became aware of the Motion Globe [14] manufactured by the Turtle Tech Design Company. This globe comprises an inner (Earth globe) sphere floating inside a thin, transparent, liquid-filled, outer spherical shell. The surface of the inner sphere is almost 0.635cm (0.25in) in from the outer ~12.7cm (5in) diameter shell, yet appears to completely fill the shell due to the magnification of the liquid and shell. The inner sphere of the commercial globe is rotated on its axis using a hidden bar magnet aligned with the earth's magnetic field. The non-rotating magnet provides a stationary platform for a tiny motor which slowly rotates the inner sphere. The motor is powered by solar-cell-derived light coming through the outer shell, which though visually opaque, is actually transparent to infrared light. The illusion, when this novelty item is spinning, is as though the earth is (impossibly) rotating while on a fixed, non-moving stand.

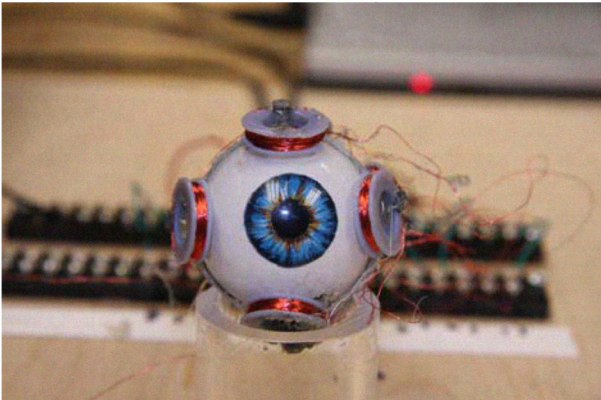


Fig. 4. Final Version of Eye (Front View)- The combination of the two previous prototypes, combining fluid suspension and an electromagnetically driven system.

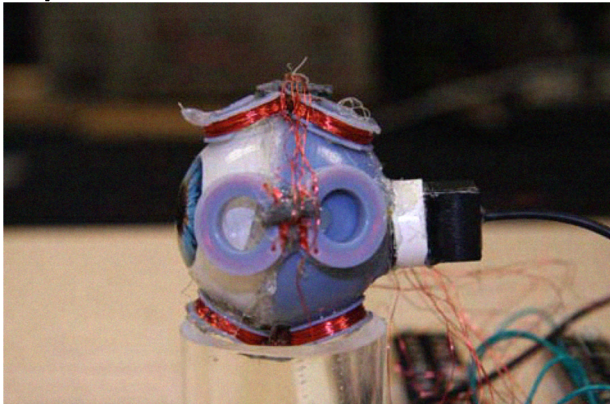


Fig. 5. Final Version of Eye (Side View)

Our Eye uses the sphere-in-a-sphere magnification illusion to good effect. Even though our inner eye is smaller than its outside shell, the overall eyeball appears to be the exact diameter of the shell. Because of this illusion, our

eyeball can “rotate” while its outer surface remains fixed in its mountings.

### A. Optical Structure and Fabrication

An important feature of our approach is that the outside of the Eye does not move. We float a transparent, solid, eyeball sphere in a transparent shell. The shell and sphere's indices of refraction match that of the floatation liquid. Thus, the entire structure, with its internal moving eyeball, is essentially one large transparent sphere. To make this eye “see”, we place a naked CCD behind the eye and use the entire spherical ensemble as a lens. This entire system becomes a camera.

In order to create a believable organic-looking eye, a realistic pupil, iris, and sclera must be visible from the front of the eye. However, to achieve this effect and not interfere with the camera's optical path is nontrivial. We have pursued several methods; the one producing the best results so far is described here.

In manufacturing our eye, we found it more precise and reproducible to use a mix of clear and stereo-lithographically-produced, opaque hemispherical parts. Referring to Figure 6 and Figure 7, the optical path from the front of the eye to the back is described in the following paragraphs.

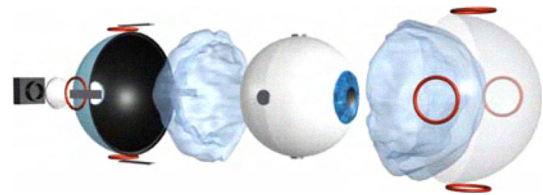


Fig. 6. Exploded Model (Front View), detailing layered structure.

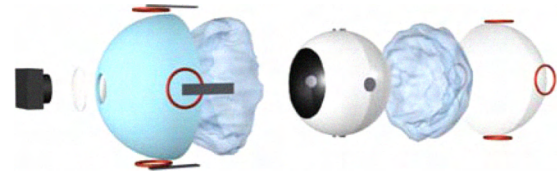


Fig. 7. Exploded Model (Back View)

The front half of the outer shell is a hemisphere of transparent PETG plastic, and is left clear. Since this shell is effectively the front of the camera's lens, we required an optically smooth, and accurately-shaped, hemispherical shell. Low-cost commercially-available plastic shells were of insufficient quality, having mold marks and other aberrations. We manufactured our hemispheres by vacuum-pulling thermo-plastic PETG at high temperatures into a hemispherical mold, terminating the pull just before the plastic made contact with the mold. Although this process results in slightly less than full hemispheres, this is compensated for by fitting this piece into the more-than-hemispherical precision stereo-lithographic back shell.

In a manner similar to the human eye, we leave a pupil-sized clear area at the front of the solid, transparent, inner sphere. The remainder of the front of the inner sphere is made opaque with a layer of black paint. It is then painted over as needed for a colorful iris and white sclera. A large part of the back of the inside sphere is left transparent to provide a clear view for the CCD, even when the eye is rotated. The inside of the back (stereolithographic) shell is painted black and formed with a small, central hole. This hole is filled in with a spherical section cut from a transparent hemisphere of the same diameter as the front hemisphere. A section of slightly smaller or larger curvature may be used to adjust the focus. This opaque shell and clear section form the back of the overall eyeball lens. The CCD at the back of the eye is selected to be physically small, and thus to require only a small opening as its aperture.

The space between the inner and outer shells is filled with a mixture of approximately 3/4 glycerin and 1/4 water, and serves three purposes. It roughly index-matches the plastics, making all internal interfaces disappear optically. It matches the average specific gravity of the inner sphere (including its small entrained magnets), thus rendering the internal sphere neutrally buoyant and preventing frictional rubbing on the top, bottom, or sides of the outer sphere. Finally, the viscosity of the glycerin/water mix provides a damping force on the rotation of the inner sphere, preventing over-spin during rapid eye-movements.

This rather simple structure of solid internal sphere and transparent outer shell provides a clear view through the eye even during pupil rotation. This is because the pupil is located behind the front surface of the (entire eyeball) lens. It is completely out of camera focus and therefore only acts as an aperture stop. At the extremes of eye movement, the overall light available to the camera decreases because of the oblique position of the pupil, but the AGC of the CCD system compensates for this. The depth of field also increases somewhat at the extremes of the eye movement, and some spherical aberration becomes apparent.

Before settling on this technique, we briefly explored other ways to fabricate an eye that could be seen through from the back, but which preserved the look of a human eye from the front. We experimented with the use of a perforated sheet of nominally opaque material to be applied to the front of the solid inner eye. This is similar to the concept of Bus Wrap [20] where passengers in modern city buses do not see advertisements pasted on the bus windows, while outside viewers do. The issue here is in fabricating holes fine enough to make their effect negligible in the image. We also investigated the use of the inverse of Bus Wrap, using fine painted image points on the front of the eye, similar to half-tone printing. These techniques, in the available degrees of granularity, obscured an unacceptable amount of the camera's image.

We also considered infrared (IR) transparent pigments, (e.g., the camera images only IR light, and the frontal eye image is painted with a pigment that is transparent to IR [24], but opaque to visible light). However we were unable

to acquire pigments of this type in the required range of visible colors.

Additionally, we explored methods in which the actual lens of the camera is embedded in a hollow, rather than solid, internal sphere. However, it was deemed that the additional complexity was not worth any optical benefits.

Other camera scenarios were considered, similar to the Self-Contained Eye described in the previous section, where the camera and lens are both mounted inside the inner rotating sphere. In this case, the camera would need to be entirely wireless, including video transfer and power supply (possibly induction coupled), since it is impractical to open the liquid-filled eye once it is sealed.

Each of these techniques might be used in specific situations. However, our current approach minimizes the number of optical surfaces between the camera and viewed objects, making fabrication much simpler and less costly.

### B. Electromagnetic Drive Mechanism

To swivel the eye, it is critical that no net translational force be applied to it. We were careful to use a magnet/coil configuration that is symmetrical, and always exerts balanced forces around the center of the eyeball. This insures that only rotational torques are applied to the internal sphere. In this manner, friction by rubbing against the bottom or sides is prevented.

There are 4 small, 4.76mm (3/16<sup>th</sup> in.) square x 1.59 mm (1/16<sup>th</sup> in.) thick, rare earth, permanent magnets (see Figure 6 and Figure 7) mounted at the north, south, east and west poles of the inner-eye sphere (as it faces forward). The magnets are installed so their poles align in series across the sphere. These internal magnets are bracketed fore and aft by electromagnetic coils on the outer shell as highlighted in the cross-sectional view of Figure 8.

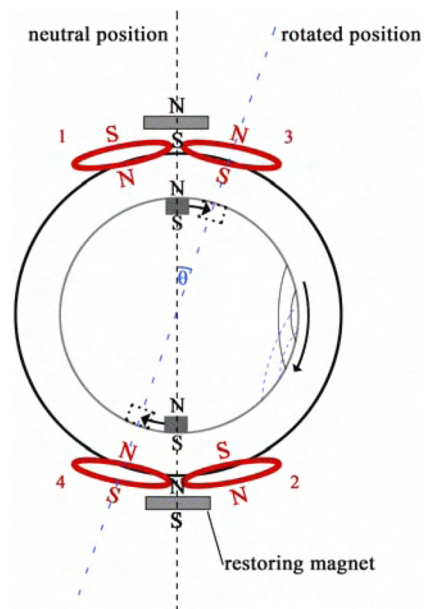


Fig. 8. Eye cross-section.

Symmetrical drive requires that the coils act in opposition. For instance as shown in Figure 8, to tilt the eye forward,

coils 3 and 4 are driven so that they attract their adjacent permanent magnet, and simultaneously coils 1 and 2 are driven so that they repel the magnet. Superimposed on these dynamic fields, is the static field of relatively weak rubberized restoring magnet strips, centered over each pair of coils. These act to return the eye's axis to the neutral position. The restoring magnets were empirically shaped to generate a quasi-uniform magnetic field across the eye, so the rest position of the internal magnets is centered between the coils.

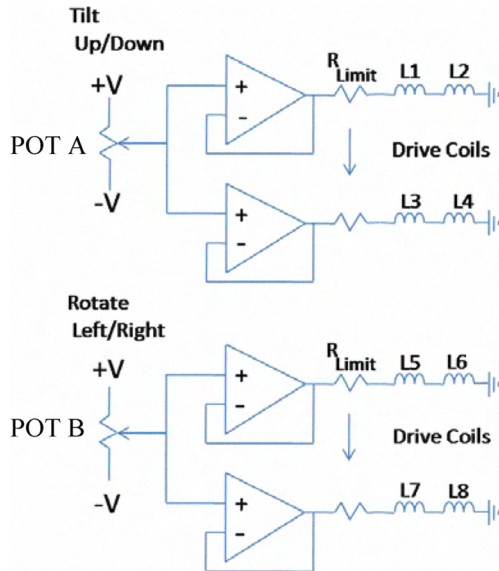


Fig. 9. Coil Drive Schematic.

A simple op-amp voltage-follower circuit, shown in Figure 9, was used to apply drive voltage, and therefore current, to alternating pairs of coils at the top and bottom, and left and right sides of the eye. The coil layout corresponding to this drive scheme is shown in Figure 10. An analog joy-stick, POT A and POT B, allowed users to quickly move the eye for testing.

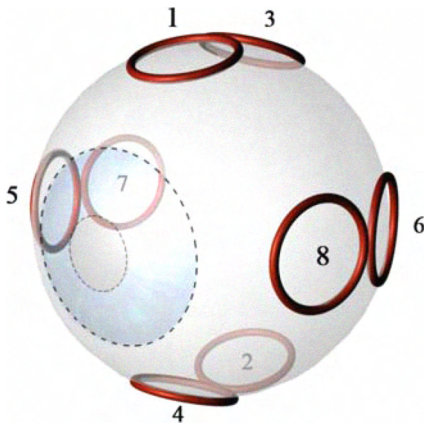


Fig. 10. Layout of drive coils, corresponding to fig. 9.

## VII. RESULTS AND DISCUSSION

The outside diameter [ $\sim 2.54\text{cm}$  (1.5 in)] of our initial prototype Fluid-Suspension Electromagnetically Driven Eye is somewhat larger than the average human eye [ $\sim 2.54\text{cm}$  (1 in) diameter]. The inner solid sphere was  $\sim 3.18\text{cm}$  (1.25 in) in diameter. The overall weight of the unit with fluid, coils and camera was 50.5g (1.7oz). We have also prototyped smaller, 2.54cm (1 in) O.D. human-sized eyes.

For both prototypes, the eye control system is run open loop. Open loop control is acceptable for many applications because the position of the eye tracks the strength of the driving magnetic field. Figure 11 illustrates the angle vs. drive current curve for the larger eye.

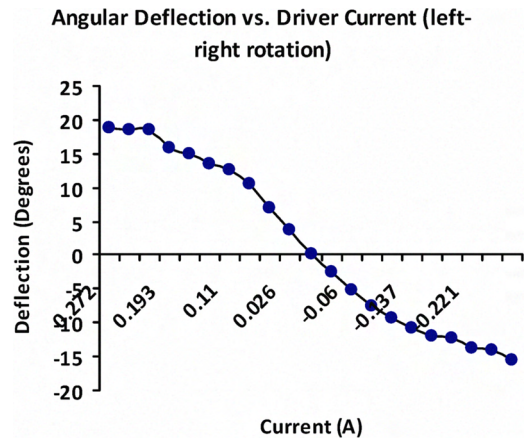


Fig. 11. Graph of Angle of Deflection vs. Drive Current.

The eye is driven to  $\sim \pm 15$  degrees yaw and tilt by approximately  $\pm 200$  mA of coil current per axis. The drive current at the neutral position is zero. The drive current can easily be reduced from its (non-optimized) value by increasing the number of windings on the drive coils (currently 100 turns of .13 mm wire for an approximate 4.6 ohm coil). Drive coils that wrap completely around the eye are also possible, freeing up more of the front-of-eye view. Maximum power dissipation occurs during maximum deflection, and is:

$$I^2R = (.272\text{A})^2(4.6\Omega)(8\text{coils}) = 2.72\text{W}$$

We measured the eye's maximum saccade rate using an NAC Image Technology, Model 512SC high-speed video camera, set at a rate of 100 frames/second. We counted frames during  $\sim \pm 20$  degree excursions of the eye (eye overshoots nominal range somewhat on rapid excursions) while driving it with an approximate square wave of current on each axis. With a 400 mA peak coil current drive, we measured peak saccade speeds of  $\sim 500$  degrees/second (in excess of the human eye speed of approximately 200 degrees/second for small excursions [1]).

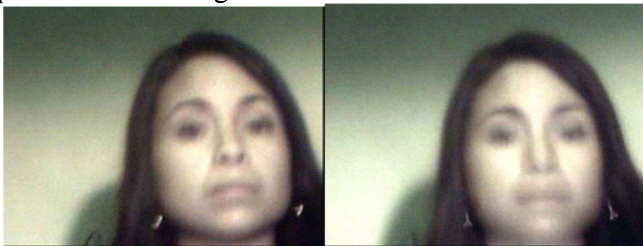
The speed/power tradeoff has not been optimized in our Eye, and can be tailored by varying the viscosity of the flotation liquid or modifying the coil structure. Adding relatively small amounts of water to the flotation solution

rapidly lowers its viscosity and supports higher speeds at a given current.

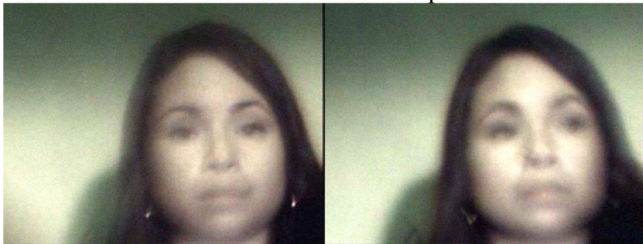


Fig. 12. Eye Video Output.

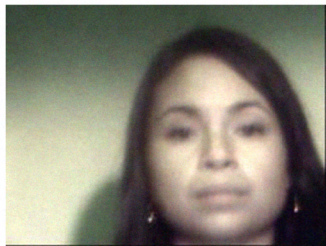
Figure 12 illustrates the camera video from the eye, and figures 13 A-E show still frames captured from the camera at its extreme left, right, and vertical tilt limits. Note that although the image is only viewed through the pupil, it is of reasonable quality, and could be fed to object tracking software. Two of our eyes and their cameras can be used to provide a stereo image of the world.



A. Max downward tilt view. B. Max upward-tilt view.



C. Maximum left rotation. D. Maximum right rotation.



E. Front center view.

Fig. 13. Camera stills from center and extreme positions.

### VIII. SPECIAL APPLICATION (MEDICAL) DISCUSSION

We have described the most compact eye embodiment, in which the drive coils are mounted directly on the eye's outer shell. There are special applications in which it is more

useful to remote the coils or other magnetic drive systems from the shell and its rotating inner sphere.

One special application would be the use of the rotary part of our eye as a human-eye prosthesis. Our eye is especially suited to this application since its outer shell does not rotate, but only appears to do so, thanks to the magnification of the inner sphere. It can be manufactured in the form of a smooth, rugged, hermetically sealed, inert ball. A person can place this eye in a vacant human eye socket, with no need to worry about rotational friction with sensitive human tissue. Since our eye is magnetically steered, the drive force can be exerted from outside the skull.

The drive for this human-embedded eye can come (as shown in Figure 14) from a modified pair of eyeglasses. The glasses can contain either a compact set of electromagnetic coils to rotate the eye, or one or more permanent magnets, which could be driven by a miniature servo system. It is even possible to contemplate a magnet rotation system, not unlike the fluid-suspended electromagnetic spherical drive we describe, but in this case, indirectly operating the eye. This system would be devoted to rotating a permanent magnet outside the skull, which in turn would drive the eye in the skull. In each case, the human-embedded eye will follow the motion of the external magnetic field.

Going further, one can imagine eye-tracking of the other (still useful) human eye as suggested in [17] and [15], using video, optical, or electro-oculography signals [9] (tracking the small voltages generated around the human eye socket when the eyeball rotates). In this case, the electromagnetic eye will match the gaze direction of the human eye. Our proposed system has the capacity to be as realistic in appearance as current prostheses and add realistic rotation.

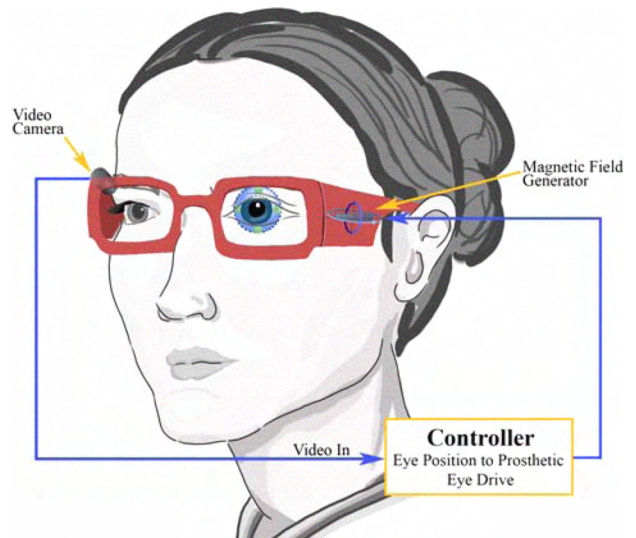


Fig. 14. Diagram of Prosthetic- Eye Application detailing drive system.

### IX. CONCLUSION

We have described several versions of magnetically and electromagnetically steered eyes suited to animatronic and other applications. The primary version of this eye, The Fluid-Suspension Electromagnetically Driven Eye, provides

significant advantages over prior approaches. It has no external moving parts while the outer surface can appear to rotate. It can easily replace existing electromechanically, pneumatically, or hydraulically steered eyes, and can work in a low-power environment. The eye also supports teleoperation and remote computer-based vision with a fixed video camera and unmoving camera view direction independent of the swivel position of the rotating eye. It provides a saccade speed greater than that of the human eye, and is low in cost and of simple construction. We described an additional application of our eye for prosthesis. In that environment, our eye's ability to be separated into a portion that can be hermetically sealed and placed into the body while being operated extra-cranially is particularly appropriate.

#### ACKNOWLEDGMENT

We would like to thank Alex Pelaez, Brian Tye, and Lance Updyke for their assistance in fabricating various portions of the eyes, Phil Jackson for his consulting on plastic materials, Scott Trowbridge for his thoughtful comments on the eye, and finally, Joe Marks for giving us a platform for our creative endeavors.

#### REFERENCES

- [1] R. Abrams, D. Meyer and S. Kornblum, "Speed and accuracy of saccadic eye movements: characteristics of impulse variability in the oculomotor system," *Journal of Experimental Psychology: Human Perception and Performance*, 1989, vol. 15, no. 3, pp. 529-543.
- [2] C. Bartneck, J. Reichenbach and A. van Breemen, "In your face, robot! The influence of a character's embodiment on how users perceive its emotional expressions, design and emotion," in *Proc. Design and Emotion*, Ankara, Turkey, 2004.
- [3] B. B. Benderson, R. S. Wallace and E. L. Schwartz, "A miniature pan-tilt actuator: The spherical pointing motor," *IEEE Transactions on Robotics and Automation*, June 1994, vol. 10, no. 3, pp. 298-308.
- [4] B. B. Benderson, R. S. Wallace and E. L. Schwartz, "Two miniature pan-tilt devices," *Proc. IEEE Int. Conf. on Robotics and Automation*, Nice, May 12-14, 1992, vol. 1, pp. 658-663.
- [5] D. Biamino, G. Cannata, M. Maggiali, and A. Piazza, "MAC-EYE: a tendon driven fully embedded robot eye," in *Proc. 5<sup>th</sup> IEEE-RAS Int. Conf. on Humanoid Robots*, Dec. 5, 2005, pp. 62-67.
- [6] C. Breazeal, "Proto-conversations with an anthropomorphic robot," in *Proc. 9<sup>th</sup> IEEE Int. Workshop on Robot and Human Interactive Communication, 2000. RO-MAN 2000*, Osaka, Sept. 27-29, 2000, pp. 328-333.
- [7] C. Breazeal, "Regulating human-robot interaction using 'emotions', 'drives', and facial expressions," in *Proc. 3<sup>rd</sup> Int. Joint Conf. on Autonomous Agents*, Minneapolis, MO., 1998, pp.14-21.
- [8] R. Brooks, C. Breazeal, M. Marjanovic, B. Scassellati, and M. Williamson, "The Cog Project: building a humanoid robot," *Computation for Metaphors, Analogy and Agents*, vol. 1562 of Springer Lecture Notes in Artificial Intelligence, Springer-Verlag, 1998, pp. 8-13.
- [9] A. Bulling, D. Roggen, and G. Tröster, "It's in your eyes: Towards context-awareness and mobile HCI using wearable EOG goggles," in *Proc. 10<sup>th</sup> International Conf. on Ubiquitous Computing*, Seoul, Sept. 2008, pp. 84-93.
- [10] K. Davey, G. Vachtsevanos and R. Powers, "The analysis of fields and torques in spherical induction motors," *IEEE Transactions on Magnetism*, Jan. 1987, vol. 23, no. 1, pp. 273-282.
- [11] B. Dehez, G. Galary, D. Grenier and B. Raucant, "Development of a spherical induction motor with two degrees of freedom," *IEEE Transactions on Magnetism*, Aug. 2006, vol. 42, no. 8, pp. 2077-2089.
- [12] C. F. DiSalvo, F. Gemperle, J. Forlizzi, and S. Kiesler, "All robots are not created equal: The design and perception of humanoid robot heads." *DIS2002*, London, 2002, pp. 321-326.
- [13] A. Foggia, E. Olivier, F. Chappuis and J.C. Sabonnadiere, "A new three degrees of freedom electromagnetic actuator," in *IEEE Industry Applications Society Annual Meeting*, 1988, pp. 137-141.
- [14] W. W. French, "Frictionless self-powered moving display," U.S. Patent 6 853 283, Feb. 8, 2005.
- [15] J. Gu, M. Meng, M. G. Faulkner, and A. Cook, "Movement control system design for an artificial eye implant," in *Proc. IEEE Int. Conf. Systems on Man, and Cybernetics*, Oct. 11-14, 1998, pp. 3735-3740.
- [16] C. D. Kidd and C. Breazeal, "Robots at home: Understanding long-term human-robot interaction," in *IEEE/RS J Int. Conf. Intelligent Robots and Systems*, Nice, Sept. 22-26, 2008, pp. 3230 – 3235.
- [17] N. Inamoto, T. Kanade and H. Saito, "Appearance based prosthetic eye," in *Proc. 2005 Int. Conf. Augmented tele-existence*, Christchurch, New Zealand, Dec. 5-8, 2005, pp. 276-277.
- [18] K. Lee and C. Kwan, "Design concept development of a spherical stepper for robotic applications," *IEEE Transactions on Robotics and Automation*, Feb. 1991, vol. 7, no. 1, pp. 175-181.
- [19] T. Pansell, H. D. Schworm and J. Ygge, "Torsional and vertical eye movements during head tilt dynamic characteristics," *Investigative Ophthalmology & Visual Science*, July 2003, vol. 44, no. 7, pp. 2986-2990.
- [20] R. M. Shields "Image display with holes for opposite side viewing," U.S. Patent 5 609 938, Mar. 11, 1997.
- [21] J. Simeray, "Electromagnetic doll's eye," International Patent Application, 10/017 854, Dec 14, 2001.
- [22] A. van Breemen, X. Yan and B. Meerbeek, "iCat: An animated user-interface robot with personality," in *Proc. 4<sup>th</sup> International Joint Conf. on Autonomous Agents and Multiagent Systems*, The Netherlands, 2005, pp 143-144.
- [23] R. S. Wallace, "Miniature direct drive rotary actuators II: Eye, finger and leg," *IEEE Int. Conf. Robotics and Automation Proc.*, May 8-13, 1994, vol. 2, pp. 1496-1501.
- [24] S. Yamamiya, H. Makino, M. Hirono, Y. Maeda and I. Ishii, "Using infrared-transparent pigments to identify objects," *Systems and Computers in Japan*, vol. 33, no. 10, pp. 74-82. Available: <http://www.interscience.wiley.com>
- [25] T. Yano and T. Suzuki, "Basic Characteristics of the Small Spherical Stepping Motor," in *IEEE/RS J Int. Conf. Intelligent Robots and Systems*, 2002, vol. 2, pp. 1980-1985.